

Digital Multi-Function Timer *Eliso*[®]

- LED dual display 11 segment for Process Value & 7 segment for Set Value
- Display height of 15mm for Process Value
- Multi voltage (88-276 VAC/DC) and Multi-range (0.01s to 999hr)
- User selectable up or down counting for Process Value
- Memory option (Retentive function) in event of break in supply
- Short depth of only 65mm
- Lock function for menu & time
- Two relay outputs
- Intuitive LED symbols for lock, relay output, memory retention, signal & time range status
- Compliant to IEC 61812-1
- IP 65 for front panel, IP 20 for terminals & IP 30 for housing





Ordering Information

Cat. No.	Description
DT124S	110 - 240 VAC/DC, Multi-Function Digital Timer - Eliso (4 Functions), 2 C/O



Digital Multi-Function Timer *Eliso*[®]



Cat. No.	DT124S				
Supply Characteristics					
Supply Voltage (Un)	110-240 VAC/DC				
Tolerance	-20%, +15% of Un				
Frequency	50/60Hz (+/-3Hz)				
Power consumption	Max 5.5VA at 240V				
Relay Output Characteristics					
Number of relays	2 C/O				
Contact arrangement	2 X SPDT				
Contact rating	NC/NO - 5A @250 VAC Resistive load				
Mechanical Life	1 X 10 ⁷ Operations				
Electrical Life	1 X 10 ⁵ Operations				
Functional Characteristics					
Display type	Dual display-11segment(PV) & 7segment(SV)				
Display color	PV-White, SV-Green, Symbol-Yellow				
No. of operating mode	4 (ON Delay, Interval, Cyclic On first & Cyclic Off first)				
Timing range	Sec	Mins	Hours	Min:Sec	Hours:Min
	999	999	999	9.59	9.59
	99.9	99.9	99.9		
Counting direction	User Selectable: Elapsed time (Up) or Remaining time (Down)				
Keypad	4 front keys as ENT, MENU, LOCK & RST				
Setting Accuracy	+/-0.05% of set time or 50 msec (whichever is greater)				
Repeat Accuracy	+/-0.05%				
Memory	10 years				
Environmental Parameters					
Operating Temperature	-10°C to 55°C				
Storage Temperature	-25°C to 70°C				
Humidity	95% Rh (Without condensation)				
Altitude	< 2000 meters				
Pollution Degree	2				
Over voltage category	III				
MTBF (IEC 62380)	Min. 177009 hrs.				
Mechanical Parameters					
Degree of Protection					
Front Panel	IP 65				
Terminals	IP 20				
Housing	IP 30				
Mounting	Panel / Flush Mountable				
Mounting Position	Any				
Dimensions (W X H X D) in mm	48 x 48 x 65 mm				
Housing	Flame retardant (UL94-V0)				
Weight (Unpacked)	Approx. 110 gm				
Certification	 				

EMI / EMC

Harmonic Current Emissions	IEC 61000-3-2 Class A
ESD	IEC 61000-4-2 Level 3
Radiated Susceptibility	IEC 61000-4-3 Level 3
Electrical Fast Transients	IEC 61000-4-4 Level 4
Surge	IEC 61000-4-5 Level 4
Conducted Susceptibility	IEC 61000-4-6 Level 3
Power Frequency Magnetic Field	IEC 61000-4-8 Level 4
Voltage Dips & Interruptions (AC)	IEC 61000-4-11
Conducted Emission	CISPR-11 Class A
Radiated Emission	CISPR-11 Class A

Environmental

Cold Heat	IEC 60068-2-1
Dry Heat	IEC 60068-2-2
Damp Heat	IEC 60068-2-30
Vibration	IEC 60068-2-6

Safety Data

Voltage Withstand Test	IEC 61812-1 2kV
Test voltage between I/P & O/P	IEC 61812-1 2.5kV
Test voltage between all terminals and enclosure	IEC 61812-1 4kV
Impulse voltage between I/P & O/P	IEC 61010-1,
Insulation resistance	>100Mohm And
	>500Mohm/250VDC/
	1min
Leakage current	< 3.5mA UL508
Single Fault test	IEC 61010-1



Digital Multi-Function Timer *Eliso*[®]



FUNCTIONAL DIAGRAMS

Mode 1 - On Delay

1. On application of supply voltage & start signal, preset time duration (T) starts. On completion of the preset time output relays 1 & 2 are switched ON.
2. On the application of reset signal time & relay are reset.
3. For continuous application of start signal, the preset time duration does not restart until the device gets a reset signal.

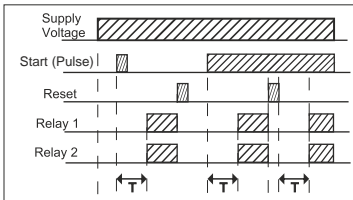

Mode 2 - Interval

1. On the application of the supply voltage & start signal, preset time duration (T) starts & Output relays 1 & 2 are actuated till pre-set time (T) is completed.
2. On the application of reset signal run/process time & relay are reset.

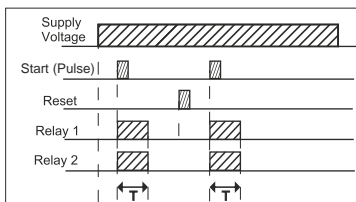

Mode 3 - Cyclic ON First, Mode 4 - Cyclic OFF First

1. On the application of supply voltage & start signal, the output relays 1 & 2 are initially switched ON for preset time duration (T1) & then switched OFF for preset time duration (T2).
2. Cyclic OFF first - On application of supply voltage & start signal, the output relays 1 & 2 are initially switched OFF for preset time duration (T1) & then switched ON for preset time duration (T2).
3. The cycle repeats and continuous till supply is present.
4. On the application of reset signal run/process time and relay are reset.

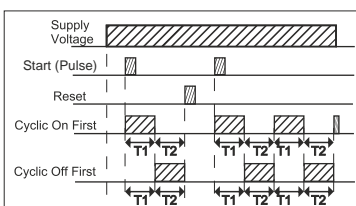
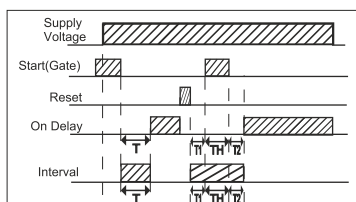
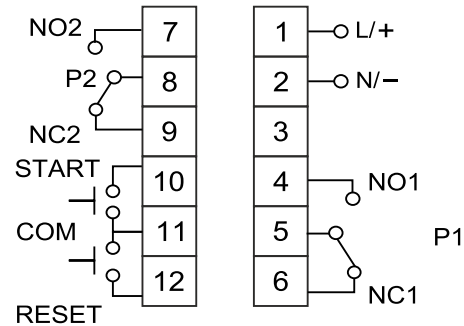

Illustration for Gate Signal - On Delay, Interval Start - Gate



1. On the application of supply voltage & Gate signal, the preset time (T) does not start & relay outputs remain OFF.
2. After removing the Gate signal preset time (T) starts. For ON delay mode, the relay outputs are switched ON after completion of preset time (T). For interval mode, the relay outputs are switched ON for the duration of preset time (T).
3. During the preset time if the gate signal is applied then the preset time pauses till the gate signal is present.



CONNECTION DIAGRAM

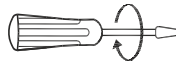

TERMINAL TORQUE & CAPACITY

 Ø 3.5 mm...4.0mm	0.5 N.m (4.5 Lb.in)
	2 x 1.5 mm ² Solid/Stranded Wire
AWG	1 x 24 to 15

MOUNTING DIMENSIONS (mm)

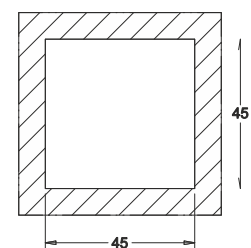
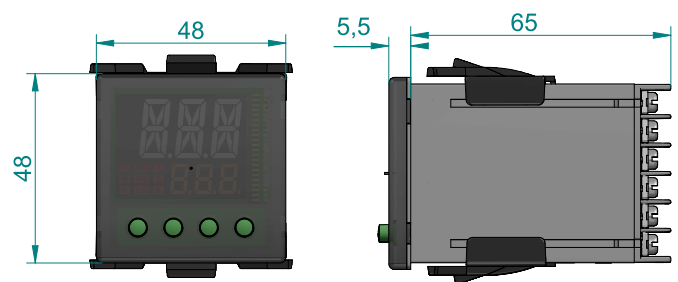

RECOMMENDED PANEL CUTOUT
45 mm X 45 mm +0.5 mm